

## DESAGÜES NORMALES AL EJE DEL PUENTE

TERRAPLEN S/REVESTIMIENTO

PLANTA

ESCALA = 1:50

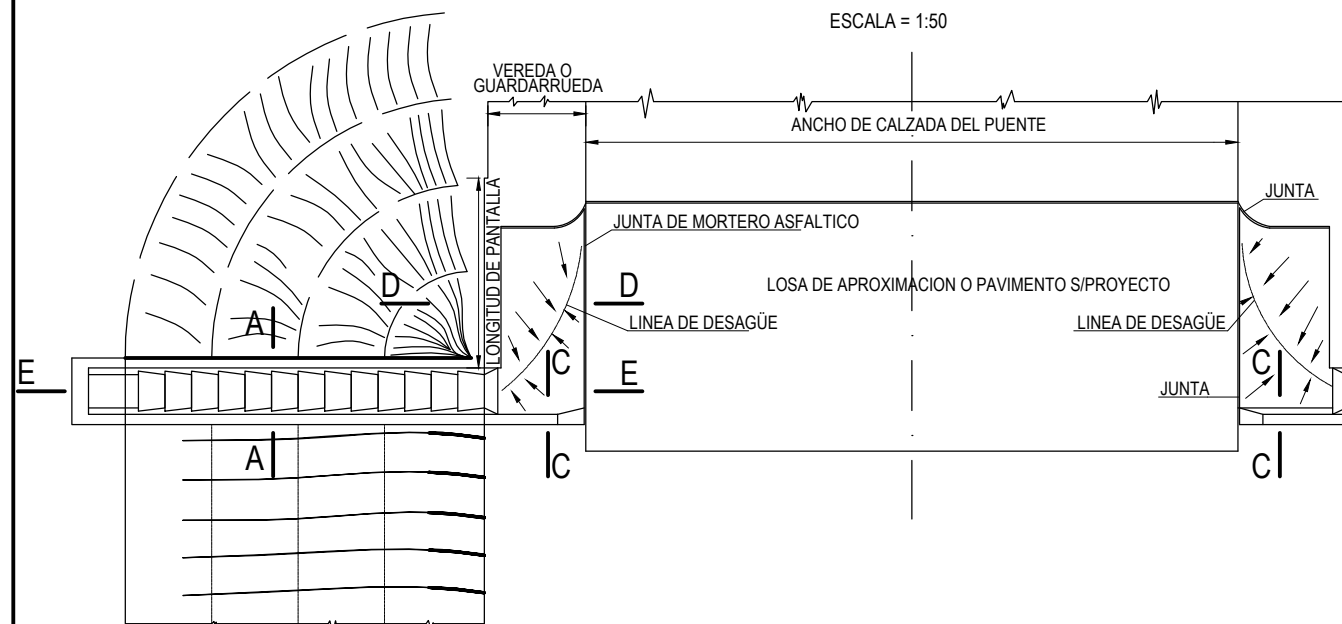

TERRAPLEN C/REVESTIMIENTO

DESAGÜE PARALELO AL EJE  
DEL PUENTE

PLANTA

ESCALA = 1:50

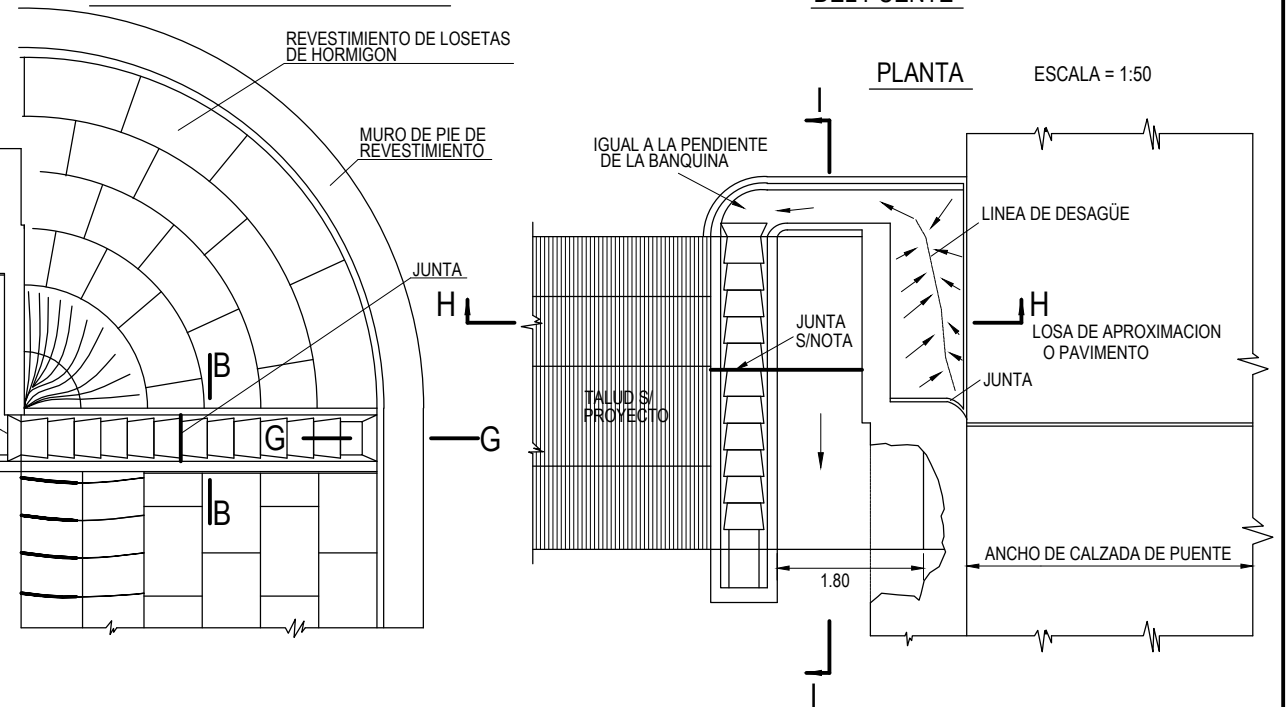

CORTE A-A

ESCALA = 1:25

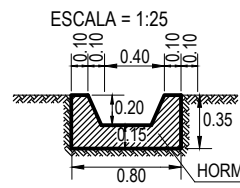

CORTE B-B

ESCALA = 1:25

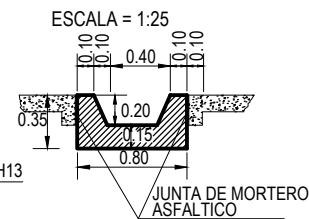

CORTE C-C

ESCALA = 1:25

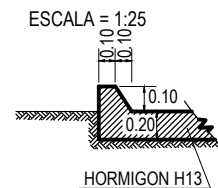

CORTE D-D

ESCALA = 1:25

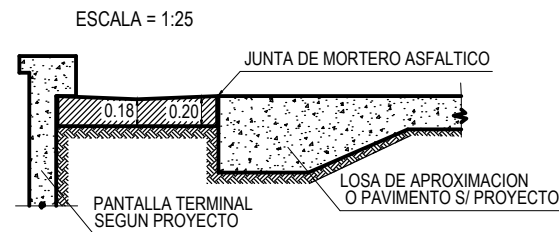

CORTE H-H

ESCALA = 1:50

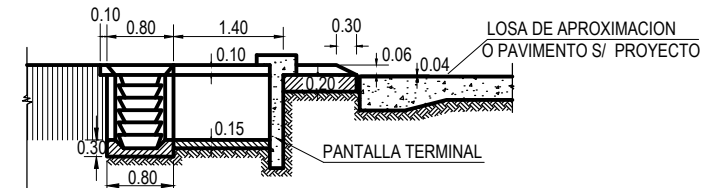

CORTE E-E

ESCALA = 1:25

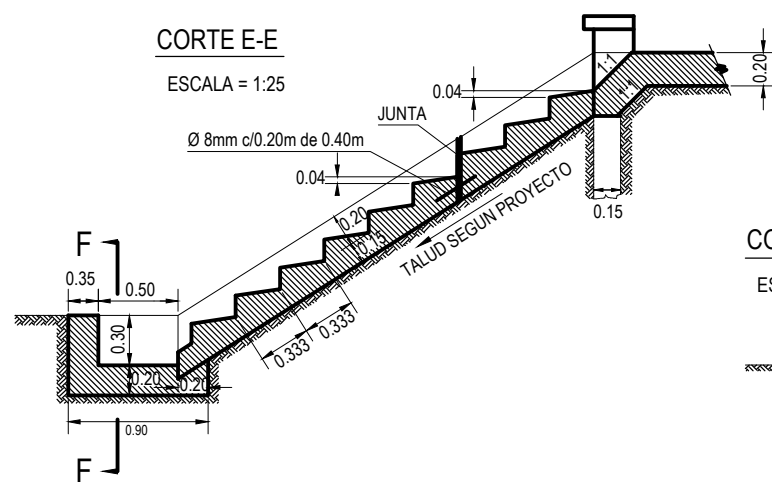

CORTE E-E

ESCALA = 1:25

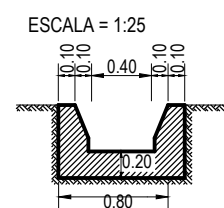

CORTE G-G

ESCALA = 1:25

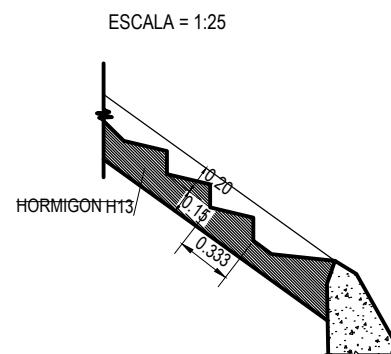

CORTE I-I

ESCALA = 1:25

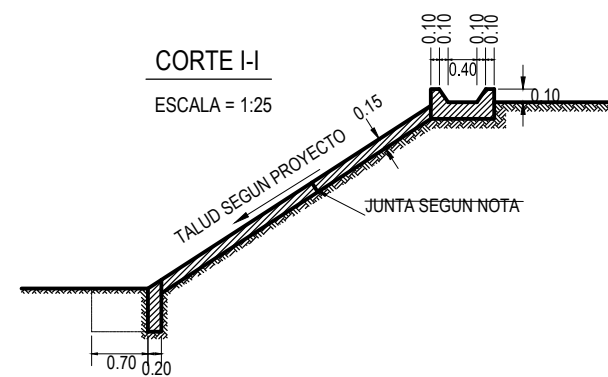

**JUNTAS:** TODAS LAS JUNTAS SERAN DE MORTERO ASFALTICO 1:3 DE ESPESOR 2cm. EN LA CANALETA DE DESAGÜE SE HARAN JUNTAS CADA 2cm. CON PASADORES DE 8mm. c/0.20cm. DEBIENDO ESTAR ENGRASADO UNO DE LOS EXTREMOS.

**MATERIALES:**  
HORMIGON: H13  
ACERO: ADN 420